

Power Distribution Board

Input

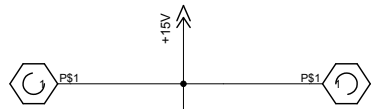

Connect:

Soldering Nut M3
Faston 6.3 x 0.8mm

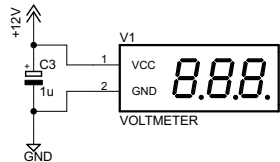
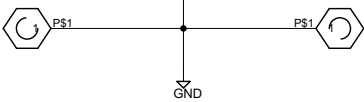
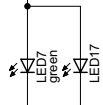

- H1 MOUNT-HOLE3.0
- H2 MOUNT-HOLE3.0
- H3 MOUNT-HOLE3.0
- H4 MOUNT-HOLE3.0

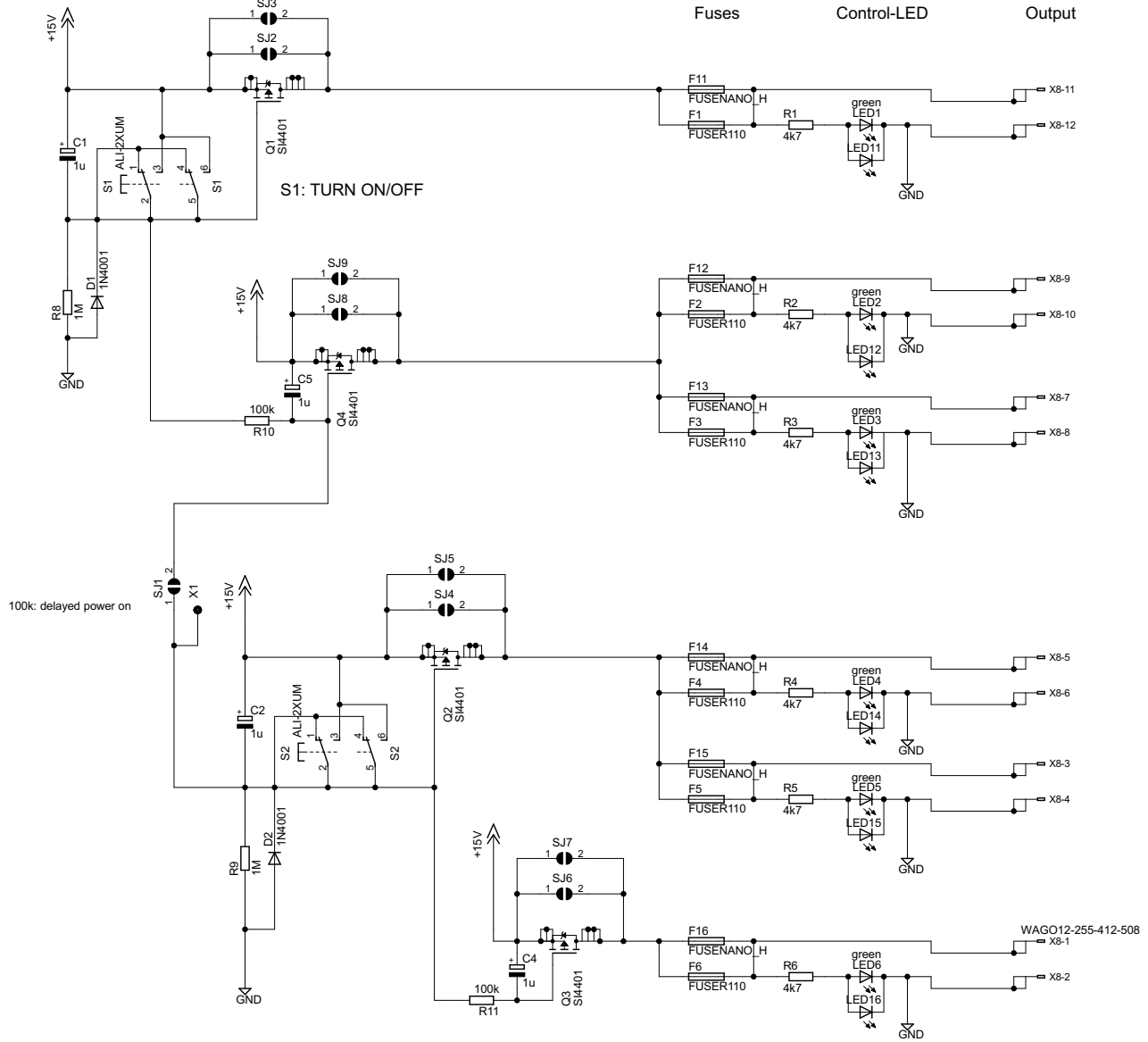

www.opendcc.de (c) Jürgen Brenner	Powerboard_1.0
	11.03.2016 09:41:51
	Sheet: 1/1